

Model DBR5125

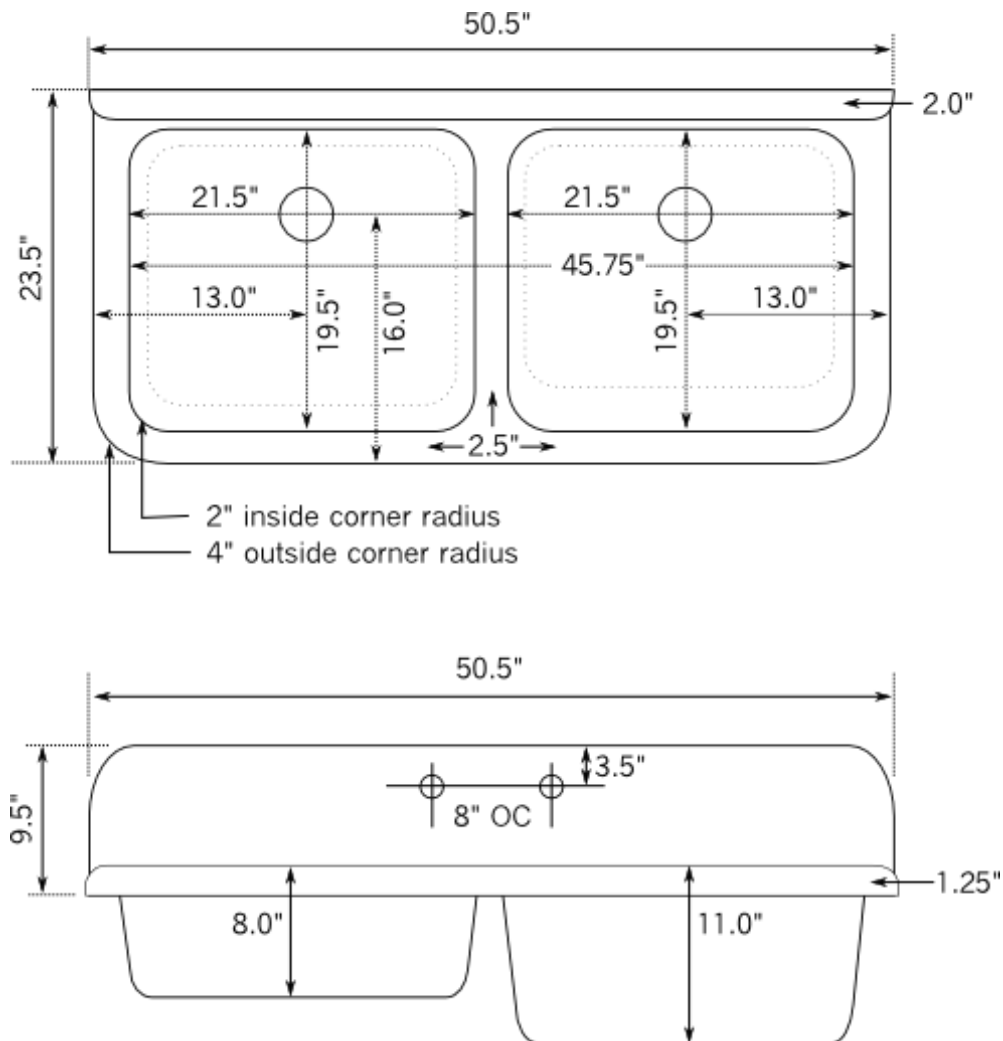

All designs and specifications are subject to change without notification. All measurements are $\pm \frac{1}{4}$ "